

Data Sheet

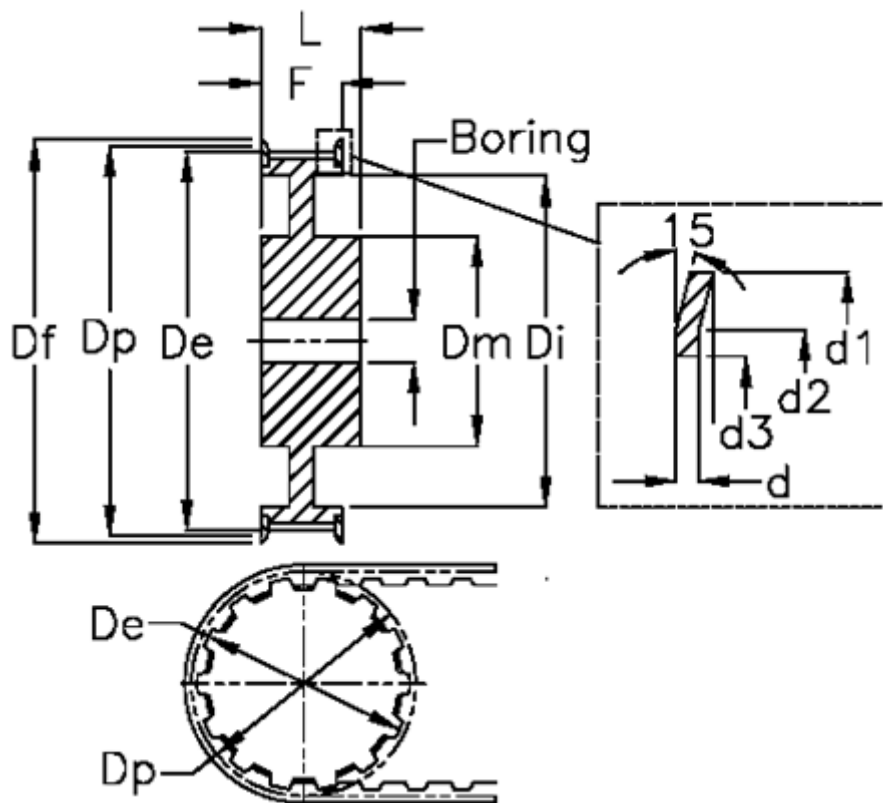

Article number: 604144064020
 Description: Timing belt pulley with hub
 HTD 64 8M 20

Measures



Bore = 15	Dm = 80	Width = 20
d = 1.5	Dp = 162.97	
d1 = 168	F = 137	
d2 = 161	Flange type = F52	
d3 = 148	L = 28	
De = 161.6	Tooth number = 64	
Df = 168	Type = 8M	
Di = 38	Weight = 2.9	